

**Receiver**
**From**

 Society  
 Reference  
 Address  
 Phone  
 Fax  
 E-mail

**Motor Code :**

60141231

**Motor :**

4TW 1,1 kW 230 V M

**Materials**

Internal sleeve and outer casing	Stainless Steel AISI 304 L
Shaft extension	Stainless Steel AISI 304
Upper support	Teflon coated cast iron
Bearing cover	Stainless Steel AISI 304
Lip seal	Nbr
Gasket	Nbr
Lower support	Teflon coated cast iron
Bellow seal	EPDM
Capacitor enclosure	Noryl
Thrust bearings	Stainless steel-Graphite
Valve	Stainless Steel AISI 304
Cable	EPDM
Connector plug	Stainless Steel AISI 316
Sand guard (fixed-mobile)	Nbr
Screws	Stainless Steel AISI 304
Coolant	Antifreeze+Water

**Motor data**

Motor brand :	TESLA		
Nominal power P2:	1.1 kW		
Rated speed :	2830 rpm		
Rated voltage :	1~ 230 V	50 Hz	
Nominal current :	8.6 A		
Degree of protection :	IP 68		
Inverter application :	Allowed		
Power factor :	0.92		
Efficiency :	62 %		
Cable section Ø mm <sup>2</sup> :	3x1,5		
Cable length m. :	1,7		
Cooling flow :	min. 0,3 m/s at 35°C		

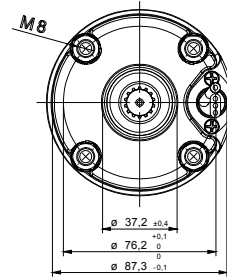
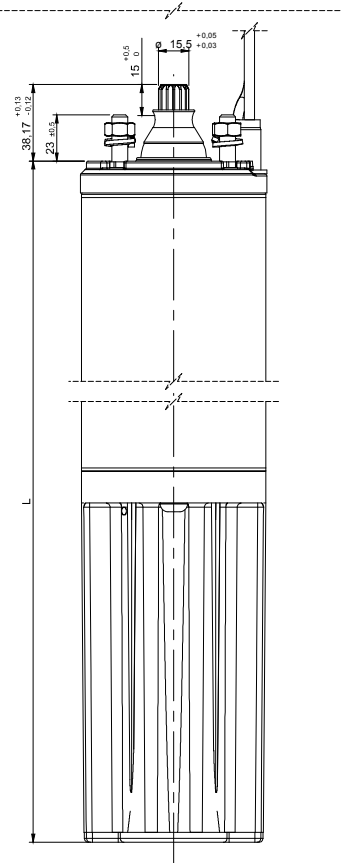
**Weight :** 11.5 kg

**Dimensions in mm**

L	500				